











33 870 809



- Ausladung 240 mm
- schwenkbarer Auslauf 360°
- optional schwenkbegrenzbar mit Schwenkbegrenzungsset 12 823 970 90
- luftangereicherter Strahl und Brausestrahl
- Metallbrauseschlauch 1800 mm
- Sprayface mit Antikalk-System
- Durchfluss max. 8 l/min bei 3 bar Fließdruck
- bleifrei
- Dieses Produkt leistet einen Beitrag zur Erfüllung der Vorgaben von nachhaltigen Gebäudezertifizierungen, z.B. LEED®, BREEAM®, DGNB

Eigensicher gegen Rückfließen.

	Chrom	33 870 809-00
	Platin gebürstet	33 870 809-06
	Platin	33 870 809-08
	Messing (23kt Gold)	33 870 809-09
	Dark Chrome	33 870 809-19
	Messing gebürstet (23kt Gold)	33 870 809-28
	Schwarz matt	33 870 809-33
	Champagne gebürstet (22kt Gold)	33 870 809-46
	Champagne (22kt Gold)	33 870 809-47
	Chrom gebürstet (Edelstahl-Look)	33 870 809-93
	Dark Platinum gebürstet	33 870 809-99

Empfohlenes Zubehör

Schwenkbegrenzungsset - 12 823 970 90



Empfohlenes Zubehör

VAIA Spender mit Rosette - Chrom 82 434 809-00



33 870 809

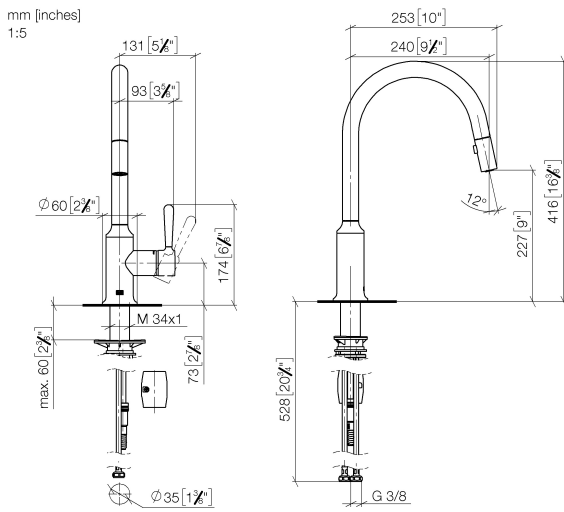

Durchflussdiagramm



Zertifikate

LGA_28657.

Belgaqua_24-005-
27_3.

33 870 809



Ersatzteilstückliste

Nr.	Artikelnummer	Benennung	Verbaumenge	Lieferzeit
1	90 28 22 397 00-00	Auslauf	1	10
2	90 15 05 064 05 90	Kartusche	1	2
3	09 14 10 190 90	Dichtung	1	2
4	09 28 30 030-00	Haube	1	10
5	90 20 80 052 00-00	Griff	1	10
6	04 28 20 067 00 90	Rohr	1	2
7	90 24 03 253 00 90	Adapter	1	2
8	04 30 02 120 00-00	Schlauch	1	10
9	04 21 50 010 00 90	Zubehoer	1	2
10	04 30 04 101 00 90	Schlauch	2	2
11	04 30 11 040 00 90	Befestigungssatz	1	2
12	90 18 40 317 00-00	Brause	1	10